

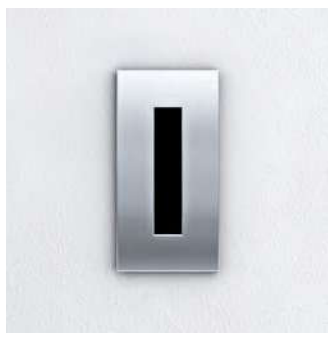

	Mono R 30 holder set for wooden panels	Mono R 30 G holder set for plasterboard	Fixing set for Mono R 30 / Mono R 30 G holder
			
Dimensions			
Characteristics	<p>Max. weight load = 20 kg per holder</p> <p>ⓘ Observe the assembly and operating instruction</p>	<p>Max. weight load = 20 kg per holder</p> <p>ⓘ Observe the assembly and operating instruction</p>	<p>To be screwed to the back of wooden panels.</p> <p>Max. weight load = 20 kg</p>
Order number	<p>chrome ● 300-572.01</p> <p>silk ● 300-572.30</p> <p>Incl. 6 wood screws.</p>	<p>chrome ○ 300-603.01</p> <p>silk ○ 300-603.30</p> <p>Incl. 6 countersunk screws for wall upright.</p>	<p>raw silk ○ 300-609.31</p> <p>Consisting of adapter and suspension lug.</p>



Front arm, straight 30 x 15 mm

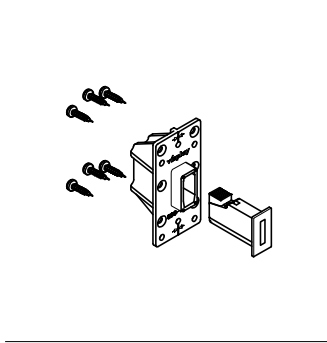
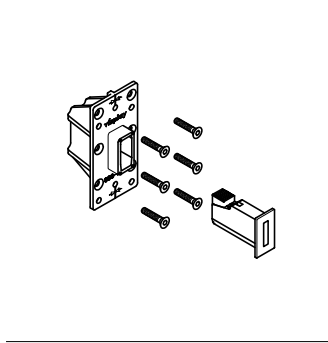
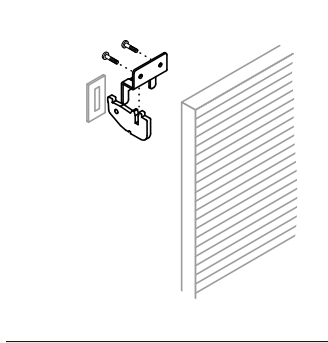
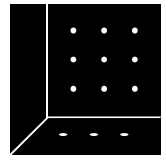
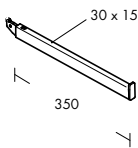

Max. weight load = 20 kg

chrome	<input type="radio"/>	362-221.01
silk	<input type="radio"/>	362-221.30

Hanging rail 30 x 15 mm, 600 mm

T arm

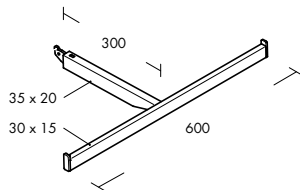

Max. weight load = 20 kg

chrome	<input type="radio"/>	362-222.01
silk	<input type="radio"/>	362-222.30

Support bracket 30 x 5 mm
for wooden or glass shelf

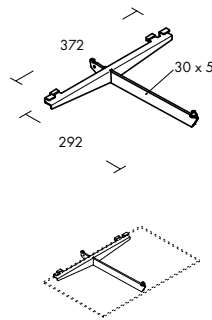

Max. weight load = 20 kg

Max. display depth = 380 mm

- 🔗 Drawing no. 978-388 Glass shelf 8 mm
- 🔗 Drawing no. 375-895 Wooden shelf 19 mm

chrome	<input type="radio"/>	362-248.01
silk	<input type="radio"/>	362-248.30

Bracket 30 x 5 mm
for hanging rail 30 x 15 mm

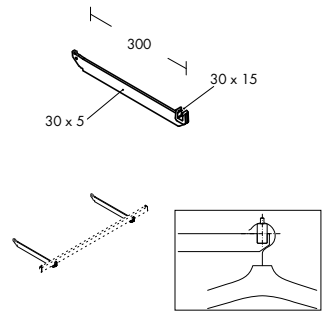
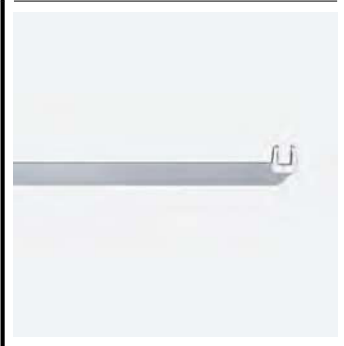

Coat-hangers can slide along the entire length of the hanging rail.

Max. weight load = 20 kg per bracket

chrome	<input checked="" type="radio"/>	391-730.01
silk	<input checked="" type="radio"/>	391-730.30

At least 2 brackets are required per hanging rail.

Bracket 30 x 5 mm
for hanging rail 30 x 15 mm and
wooden or glass shelf

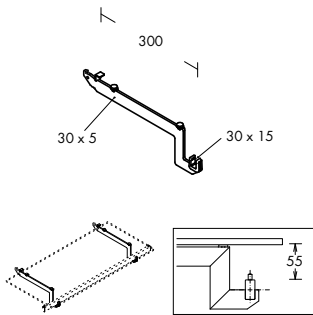

Coat-hangers can slide along the entire length of the hanging rail.

Max. weight load = 20 kg per bracket

Max. display depth = 380 mm

☛ Drawing no.
286-620 Glass shelf 8 mm

☛ Drawing no.
980-299 Wooden shelf

chrome

● **391-732.01**

silk

● **391-732.30**

At least 2 brackets are required per hanging rail and shelf.

Hanging rail 30 x 15 mm
rectangular tube

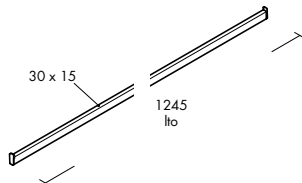

To be inserted into brackets for hanging rail.

chrome

1245 mm ○ **315-756.01**

to 620–2445 mm ○ **315-758.01**

silk

1245 mm ● **315-756.30**

to 620–2445 mm ○ **315-758.30**

620–1245 mm => 2 brackets
1246–1870 mm => 3 brackets
1871–2445 mm => 4 brackets

Bracket 30 x 5 mm
for wooden or glass shelf

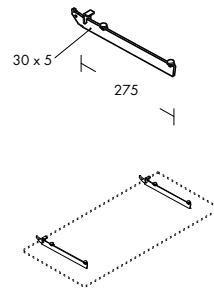

Max. weight load = 20 kg per bracket

Max. display depth = 380 mm

☛ Drawing no.
286-620 Glass shelf 8 mm

☛ Drawing no.
980-299 Wooden shelf

chrome

● **340-306.01**

silk

○ **340-306.30**

At least 2 brackets are required per shelf.

Clamping bracket
for glass shelf

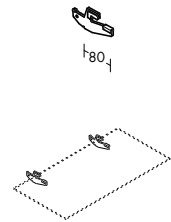

Max. weight load = 15 kg per bracket

Max. display depth = 380 mm

☛ Drawing no.
286-620 Glass shelf 8 mm

silk

● **340-297.30**

At least 2 brackets are required per shelf.

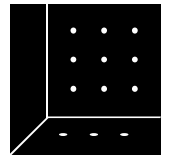

Scissors



100 x 

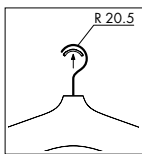

Prevents scratches on hanging rails and front arms in silk or stainless steel.

To clip into coat hanger hook (Ø 3.4–3.8 mm).

transparent

● **929-449.02**

Set of 100 pcs.